

Drive & Control Academy Fluid Power Training Systems

Training topics for industrial and mobile hydraulics – North America



03 Drive & Control Academy

05 Training Systems

- 06 TS-DS2NA (entry level training stand)
 - 09 TS-DS4NA (entry level plus advanced technologies)
-

13 Learning topics

- 15 Learning topics – Overview

16 Industrial hydraulic topics

16 Learning topics – On/off hydraulics

- 17 Common order examples
- 18 ON/OFF hydraulics
 - Manually operated valves
- 20 ON/OFF hydraulics
 - Electrically operated valves

- 24 Recommended accessories

- 25 Simulation software I/O module

- 26 Troubleshooting

- 27 Troubleshooting manually operated valving

- 27 Troubleshooting solenoid operated valving

29 Learning topics – Continuous control valves

- 30 Proportional (open loop) control

- 34 Servo (closed loop) control

- 38 Recommended accessories

39 Learning topics - Mobile hydraulics

- 40 Throttle (open centre) control

- 43 Load Sense control

- 46 Flow sharing LUDV (flow sharing) control

- 49 Recommended accessories

50 Additional componentry

- 51 Spare parts

52 Additional information/notes



The data specified herein only serves to describe the product. No statements concerning a certain condition or suitability for a certain application can be derived from our information. The information given does not release the user from the obligation of their own judgment and verification. It must be remembered that our products are subject to a natural process of wear and aging.

© This document, as well as the data, specifications and other information set forth in it, are the exclusive property of Bosch Rexroth AG. It may not be reproduced or given to third parties without its consent.

Drive & Control Academy

Knowledge – the decisive competitive advantage



Bosch Rexroth is one of the global leading specialists in drive and control technology and has unique technological know-how. This knowledge is passed on by the Drive & Control Academy and supports the customized training and further development as well as the qualification of technical specialists.

Knowledge is everything

Technical knowledge and competence of its employees provides a company with a decisive advantage in global competition. Under the umbrella of the Drive & Control Academy, Rexroth offers an extensive portfolio of products in the area of drive and control technologies knowledge transfer. These products are continuously updated to follow industry standards and best practices. The Drive & Control Academy are specialists in the transfer of specialized and integrated know-how for customers and employees and are able to provide training hardware for all levels of learning. With regards to this, our product portfolio has been developed with the following points in mind:

- ▶ Practical equipment focusing on the latest state of the art technology
- ▶ Training targeted towards specific user requirements
- ▶ Training utilizing the most up to date methods

Training

New training offerings and continuous improvement of the training seminars guarantee that the conveyed knowledge is always state of the art. The methodical scope of supply comprises instructor led training, eLearning, practical training and blended learning. In addition to these advantages both instructor led training and eLearning can be combined for an extremely effective training solution. When training customers we believe that the customer proximity principle is paramount.

Training systems

The training systems provide newcomers and advanced users with practical hands on learning in the areas hydraulics, pneumatics, electric drive and control technology, mechatronics and automation. These systems comprise standard industrial components and follow internationally standardized programming languages with open interfaces.

Media

Rexroth's software-based teaching and study media are distinguished by their technical accuracy and are specifically targeted to the training seminars and training systems. They are comprised of eLearning modules, technology and application trainers, animations of components and systems as well as simulation-supported training units.

This is completed by dictionaries, specialist books, manuals for trainers and trainees as well as for work equipment.

Knowledge Portal

The Knowledge Portal will develop into the multimedia contact point for all drive, control and motion technology topics in the industrial and academic training sectors and further education as well as qualification.

This unique contact point on the Internet will give the users access to high-quality information and allow for a structured exchange of knowledge and experience.



Fluid Power Training Systems DS2NA, DS4NA

Rexroth's technical know-how and solution competence in the area of industrial applications are smoothly integrated into the modularly structured training systems - in this way, they perfectly satisfy the quality levels demanded by industry.

Rexroth training systems

Bosch Rexroth training systems are based on standard components from different Bosch Rexroth product areas. A training system consists of the hardware and the training and project manuals for trainers and trainees. By means of the training systems, both newcomers and advanced users work out practical exercises and gain technical specialized knowledge step-by-step. The trainees will discover the industry standard components used in the training system in machines and systems again in their professional career. Apart from the hydraulic training system described here in the catalog, Bosch Rexroth also offers training systems in the technology areas of pneumatics, sensors, PLC and Mechatronics. Information on suitable training aides and all other offers of the Drive & Control Academy is available on the Bosch Rexroth website at the address:
www.boschrexroth.com/training

North American Fluid Power Training Systems

The DS2 and DS4 training systems are designed and manufactured in North America and allow for the transfer of knowledge in a wide range of hydraulic as well as pneumatic technology. They offer a complete solution for teaching and demonstration of the operation of modern hydraulic and pneumatic circuits and prepare the trainees for their work in the industry. Thanks to the configuration options, the training systems can be perfectly adapted to the relevant topic and extended for the use in further trainings. Due to the use of a load sensing piston pump hydraulic unit, the DS4NA

is also perfectly suited for mobile hydraulic training and is capable of demonstrating the concepts particular to mobile hydraulics using a hands-on practical approach. The device sets and the associated training manuals for the various study topics prepare the trainees for the tasks and requirements of their later professional life.

Equipment

Both the DS2NA and the DS4NA fluid power training systems can be configured and extended and can grow with changes and additions to your curriculum. Their essential components are:

- ▶ Hydraulic power unit
 - ▶ tested/certified safety valves
 - ▶ Industry standard size 6 (DO3) valves
 - ▶ Actuators with special protective covers to ensure student safety
 - ▶ Storage and mounting rack for hydraulic and electrical components
 - ▶ Heavy duty grid and/or grooved plate for mounting hydraulic, electrical and/or pneumatic components and circuits
 - ▶ Measuring glass for oil flow
 - ▶ Rotatable load simulation cylinder (optional)
- All training systems are delivered in a completely assembled and tested condition.

Select the system to match your training requirement

Based on your requirements you can choose between the DS2 and DS4 training systems per the following:

Training System DS2NA

Your perfect entry into the world of knowledge.

The DS2NA training system provides modularity, a compact footprint and practical equipment. Users benefit from a low entry price with high flexibility adaptable to the teaching topics

Entry-level system TS-DS2NA

With the DS2NA training system, Bosch Rexroth offers you an excellent cost-effective entry into the extensive world of Rexroth's training. The DS2NA training system is a compact basic solution in the technology fields of hydraulics, pneumatics and automatic control engineering and can thus be used in versatile applications.

By means of extensive accessories, the DS2NA training system can satisfy the individual requirements of companies and teaching facilities as well as adjust to a wide variety of learning topics. In conjunction with the teaching and learning media, the training system allows for customized training and qualification - from the beginner to the professional.

Modular

The DS2NA training system is very versatile and can be used in a number of different applications. The modular setup allows for customized qualification of specialists in the areas hydraulics, pneumatics and automation. Numerous different variations are available for hydraulics and/or pneumatic and controls training.

Robust, compact and expandable

The stable and durable system is constructed to industrial quality (UL/CSA) and designed for heavy industrial components. Thanks to the compact dimensions and swivel caster wheels the training system is able to fit through standard doorways. The DS2NA training system still remains very flexible and can be used wherever it is needed. The DS2NA training system can be easily extended to provide training in additional learning topics. Ample provision for accessory devices has been provided on the training stand and a separate component and hose

rack allows for storing all hydraulic and electrical devices.

Practical equipment sets

(see illustration on next page)

The DS2NA training system is equipped with industry-tested products and standard components which the trainees will find again later in their professional career in machines and systems.

One example:

the basic device set "Hydraulic Fundamentals"

- ▶ Differential cylinder with protective housing
- ▶ Pressure reducing valve, direct-operated
- ▶ 3X lever operated directional control valves
- ▶ Line mounted check valve
- ▶ Throttle and throttle/check valves
- ▶ Pressure compensated flow control
- ▶ 2X gauges with measuring lines
- ▶ 2X Hydraulic distributor
- ▶ Hose lines
- ▶ Hose lines with gauging connections

Single or double sided operation

The clear setup of the DS2NA training system simplifies the entry into the world of knowledge.

Students can experience for themselves the proper use of industry-tested components. The training system allows for both, one-sided and two-sided operation. It consists of a base frame and grids for industrial components as well as the possibility of grooved plates for the pneumatics and automation devices. The stand will accommodate up to four trainees due to the double sided grid/plate layout.

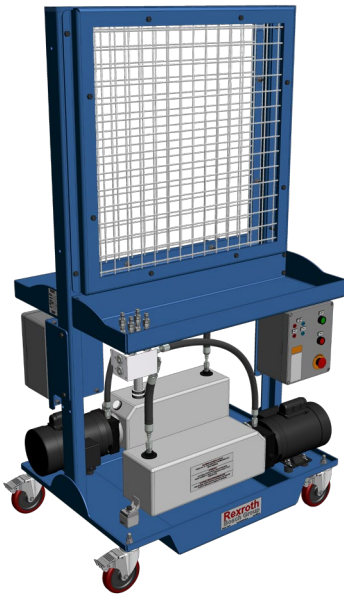

Double sided hydraulic trainer

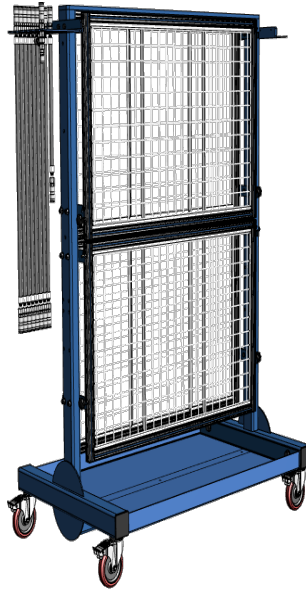

Component and hose storage rack



Double sided pneumatic trainer

Features – hydraulic trainer

- separate hydraulic reservoirs and pump/motor groups (upgradeable from single to double sided)
- Fixed displacement gear pump (8 l/min, 50 bar) (2.1 GPM, 725 psi)
- Powered via standard 120V/60Hz wall outlet
- Separate CSA/UL certified starters and 24VDC power supplies
- Dual unit (metric/imperial) instrumentation
- Heavy duty welded and powder coated steel frame

The combination of training system and component set allows training on various technologies including hydraulics, pneumatics and control engineering. This also allows flexibility of the technology level from manually operated valves to solenoid operated valving and control systems. Each component set also has an associated student manual with technical information and lab experiments as well as an instructor manual containing circuit and problem solutions



Example of a device (equipment) set

Training System DS2NA

Ordering code:

TS-DS2NA-1X				
Training technology 1 side hydraulic 1H 2 side hydraulic 2H 2 side pneumatic 2P 1 side hydraulic, 1 side pneumatic 1P1H 2 sides hydraulic, 2 sides pneumatic 2P2H				
Electrical device mounting (required for training with electrical valves) w/o central mounting panel no code c/w central mounting panel EP				
Measuring glass (required for flow measurement) w/o measuring glass no code 1 measuring glass M1 2 measuring glass' M2				
Rotatable 15 kg load simulation cylinder w/o rotatable load simulator no code 1 rotatable load simulator L1 2 rotatable load simulators L2				

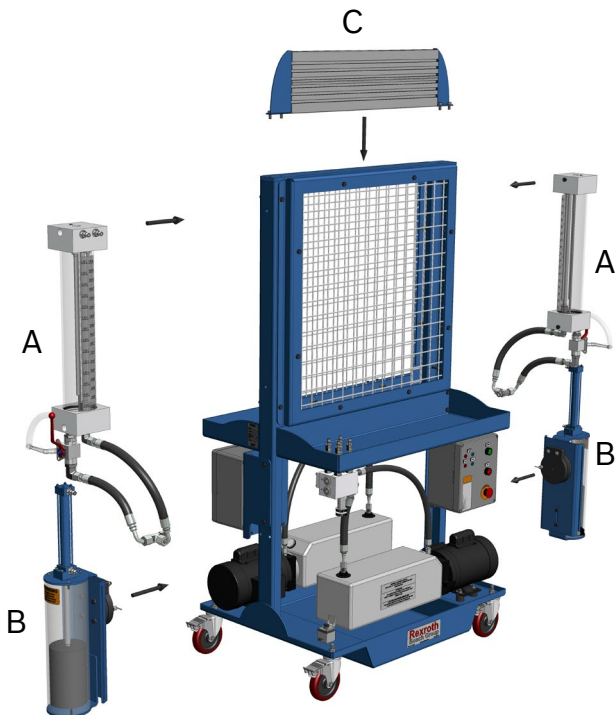

Training Stand – Optional Equipment

- A. Measuring glass for flow measurement
Recommended
- B. Rotatable load simulator cylinders
- C. Electrical device mounting panel

Training System DS4NA

An extensive package for all of your training needs.

The DS4NA training system provides unlimited possibilities for all of your fluid power training needs. From manually and electrically operated hydraulics through to open and closed loop proportional and servo control to mobile hydraulics and even pneumatics

Rexroth's training systems

Bosch Rexroth's training systems are based on standard components from the different Rexroth product areas. One training system consists of the workstation, the components contained in the device sets and the exercise books. Using component expansion sets allows the training topics to build on each other. By means of the training systems, newcomers and seasoned professionals acquire practical specialist knowledge step-by-step. The trainees will find the standard components used in the training system again later in their professional career in machines and systems. Apart from the training systems for hydraulics described here in this catalog, Bosch Rexroth also offers training systems in the fields of pneumatics, sensor technology, and PLC control which can also be taught on the DS4NA training system.

Information on suitable teaching aides and all other offers of the Drive & Control Academy are available on the Bosch Rexroth website at: www.boschrexroth.ca/training

Training stand DS4NA

The DS4NA training stand is used to impart knowledge of industrial and mobile hydraulics. By upgrading it with a grooved plate, it can also be used for pneumatics and PLC control engineering. It offers a base for training with modern hydraulic circuits and perfectly prepares the trainees for their future work in industry. Technology levels are increased through the use of component expansion sets to allow teaching in the relevant topic. Due to the use of a load-sensing power unit, the DS4NA training stand is also perfectly suited for training in mobile hydraulics. In this way, the particularities in the area of mobile applications are illustrated in a practical manner. The device sets which are available for the different topics together with the

exercise books perfectly prepare the trainees for their future professional tasks and requirements.

Equipment

The DS4NA training stand can be configured numerous ways and has additional options to allow training in multiple disciplines. The training stand basically consists of the following equipment:

- ▶ Heavy duty welded and powder coated base frame mounted on lockable swivel casters
- ▶ Hydraulic power unit with variable displacement swashplate piston pumps.
- ▶ Low operating noise
- ▶ Powered by standard 120Volt/15Amp wall outlet
- ▶ Integrated lockable component storage area under working table
- ▶ Integrated drawers for tool and small component storage
- ▶ Measuring glass with dual unit scale
- ▶ Load simulators, 15 kg, swivel-mounted (optional)

The DS4NA training stand is supplied completely assembled and tested.

Training environment

The DS4NA training stand can be equipped to match your exact requirements.

- ▶ The double sided layout of the training stand allows two groups to work simultaneously and completely independently since both sides of the stand are completely isolated from each other. The stand will accommodate up to six trainees due to the large double sided grid layout.

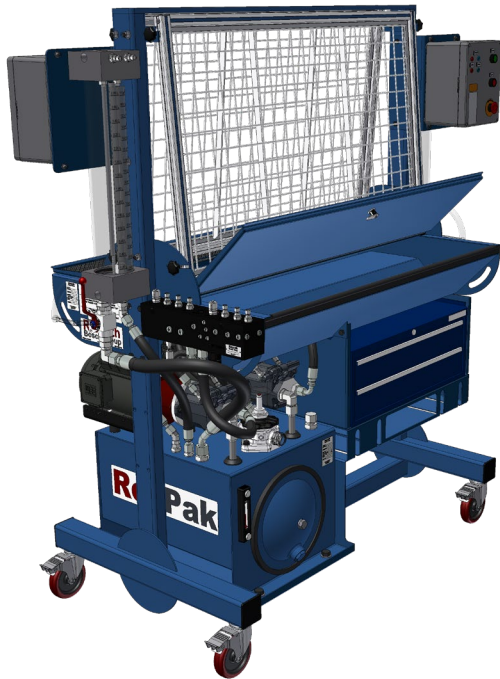

Training stand for hydraulic training

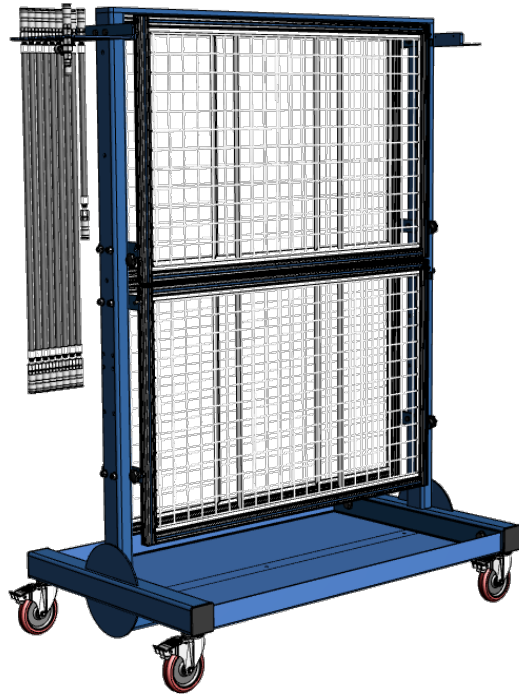

Hydraulic component and hose storage rack

Features – hydraulic trainer

- Large capacity steel reservoir with standard industry instrumentation
- Variable displacement pressure compensated/load sensing piston pumps (8 l/min, 50 bar) (2.1 GPM, 725 psi)
- Powered via standard 120V/60Hz wall outlet
- Separate CSA/UL certified starters and 24VDC power supplies
- Dual unit (metric/imperial) instrumentation
- Heavy duty welded and powder coated steel frame

The combination of training system and component set allows training on various technologies including hydraulics, pneumatics and control engineering with nearly infinite expandability. This also allows flexibility of the technology level from manually operated valves to solenoid operated valves and open and closed loop control systems.

Each component set also has an associated student manual with technical information and lab experiments as well as an instructor manual containing circuit and problem solutions. Additional accessories allow for realistic training in axis control and mobile hydraulics.

Training System DS4NA

Ordering code:

TS-DS4NA-1X / / / /

Training technology	2H 2P2H			
Electrical device mounting (required for training with electrical valves) w/o central mounting panel c/w central mounting panel	no code EP			
Reservoir viewing window Standard cleanout covers Clear polycarbonate cleanout covers	no code RW			
Rotatable 15 kg load simulation cylinder w/o rotatable load simulator 1 rotatable load simulator 2 rotatable load simulators	no code L1 L2			

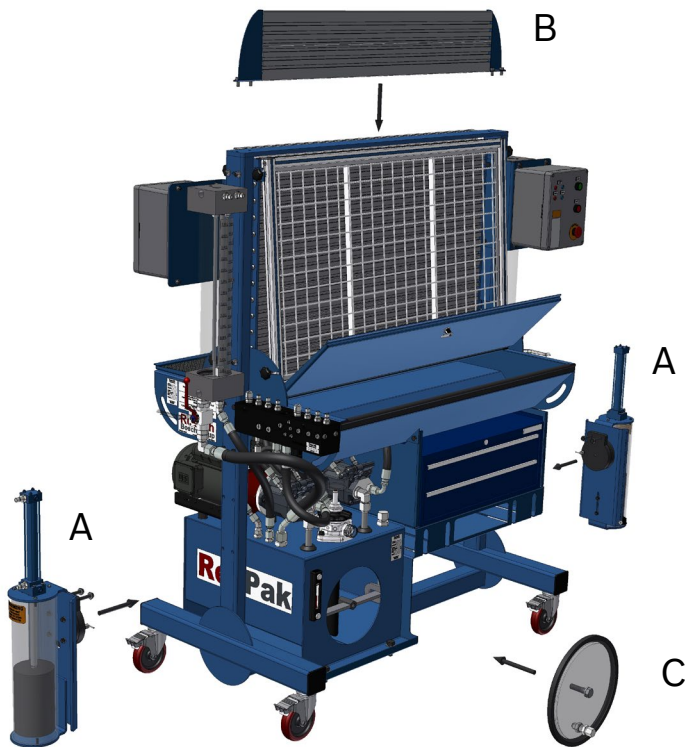

Training Stand – Optional Equipment

- A. Rotatable load simulator cylinder
R987403594
- B. Electrical device mounting panel
R987403624
- C. Reservoir viewing window set

Selecting the proper training stand

Bosch Rexroth can supply you with the proper hardware to satisfy all of your fluid power training requirements. By selecting the proper training stand and component sets it is possible to provide training in nearly all topic areas.

Highest quality

All Bosch Rexroth training systems are based on standard components from the different product areas of the drive and control specialist. Bosch Rexroth's core competency has always been hydraulics and this is highlighted in the fluid power training systems. The safe, robust, durable and easy-to-operate standard components offer trainees a seamless transition to the requirements of industry. They will see all of the valves used on the training system again in their working career in various machines and systems. Due to their large number of variants, the training stands can be selected to provide training on the relevant topic matter. Suitable teaching and learning media including Exercises and Exercises with solutions to complete the overall package.

The DS2NA training system, is a particularly cost-effective system for the practical teaching in conventional hydraulics and pneumatics. With the modularly of the training system, basic knowledge in hydraulics, pneumatics as well as automation can be imparted in an illustrative and realistic manner.

The DS2NA training system provides an entry level and basic technology system.

The DS4NA training system is capable of providing training from the basics through to advanced topic areas.

The larger working surface of the DS4NA along with perfect space utilization offers sufficient room for more complex tasks and demanding examples in the areas on/off hydraulics, continuous control valve technology and mobile hydraulics. The variable displacement piston pump also contributes to learning modern control technology and provides a load sensing control typical to mobile hydraulics.

Which stand do I need?

The DS2NA training system has an extremely attractive price for entry level technology training in industrial hydraulics or pneumatics. Topics such as proportional and servo control as well as mobile hydraulics can be taught on our tried and true DS4NA training system. The following table offers and overview of the capabilities of each system.

Learning topic	DS2NA	DS4NA
ON/OFF hydraulics – manual valves (also troubleshooting)	X	X
ON/OFF hydraulics – electrical valves (also troubleshooting)	X	X
Open loop (proportional) control		X
Closed loop (servo) control		X
Mobile hydraulics – throttle (open centre) control		X
Mobile hydraulics – load sense (LS) control		X
Mobile hydraulics – flow sharing (LUDV) control		X
Mobile hydraulics – hydrostatic steering systems		X
Mobile hydraulics – programmable electro-hydraulic joystick control		X
ON/OFF pneumatics – manual control	X	X
ON/OFF pneumatics – electrical control	X	X
PLC controlled hydraulics	X	X
PLC controlled pneumatics	X	X

Flexibility and expandability are key

Bosch Rexroth offers base a number of different options when it comes to choosing the technology to equip your training stand.

Start with the basics

Bosch Rexroth's fluid power training systems are designed first and foremost with ease of use and flexibility in mind.

The training stand can be equipped with component sets which allow training on a broad spectrum of topics including:

Hydraulics

Training is possible with lever operated or solenoid operated hydraulic valves as standard base component sets on both the DS2NA and DS4NA training stands. The DS4NA training system allows for training in open or closed loop proportional control, mobile hydraulics and multidiscipline troubleshooting via component expansion sets.

Pneumatics

A wide variety of pneumatic control valves, actuators and sensors allow the entire spectrum of pneumatic technology to be covered. Additional sensor and PLC control is also possible

Expandable for additional study topics

The training stand allows nearly infinite diversity and expansion without having to change the base hardware. Through the addition of expansion sets the training stand can be used for learning in the following topics:

- ▶ Conventional Hydraulics
lever operated and/or solenoid operated valving
- ▶ Proportional valve technology
(open/closed loop)
- ▶ PLC controlled hydraulics
- ▶ Mobile hydraulics
- ▶ Pneumatics
- ▶ Manual and/or electro-pneumatics
- ▶ Sensor and PLC technology
- ▶ Mechatronics (fluid power, sensors, PLC)

The following section gives a general overview of only some of the numerous component sets which are available.

All study topics have training manuals for both student and teacher.

For more details or for additional component sets and additional components please contact us.

The following pages show the component sets for use on both the DS2NA and DS4NA training systems. It is possible to purchase a complete component set for training on a particular technology however it is also possible to start with a basic technology component set and build to higher technology via expansion sets. This saves you money since you can utilize the componentry you already have.

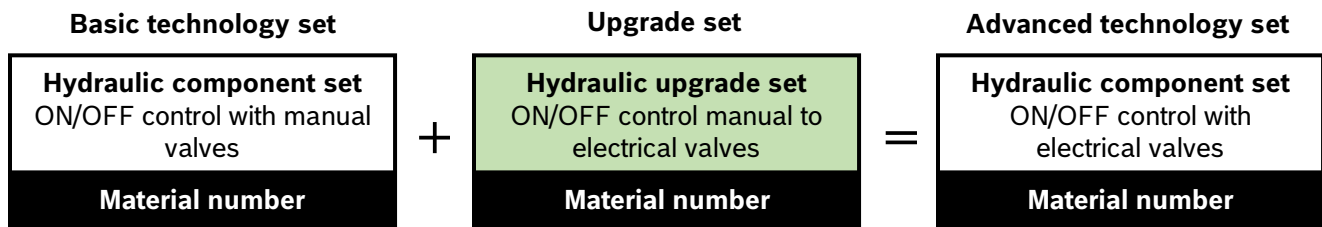

Learning topics - Overview

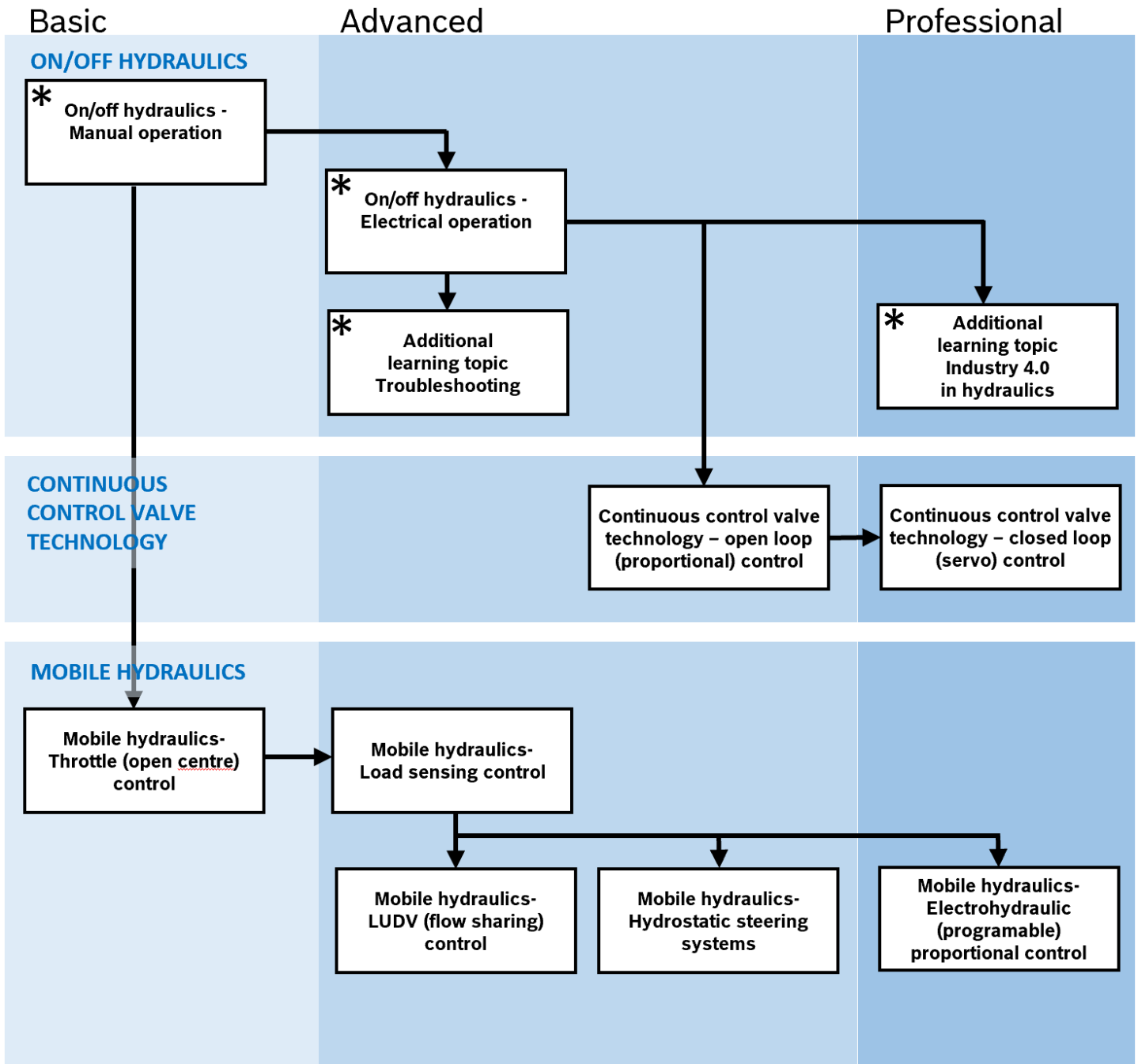

* Topics available for TS-DS2NA training system

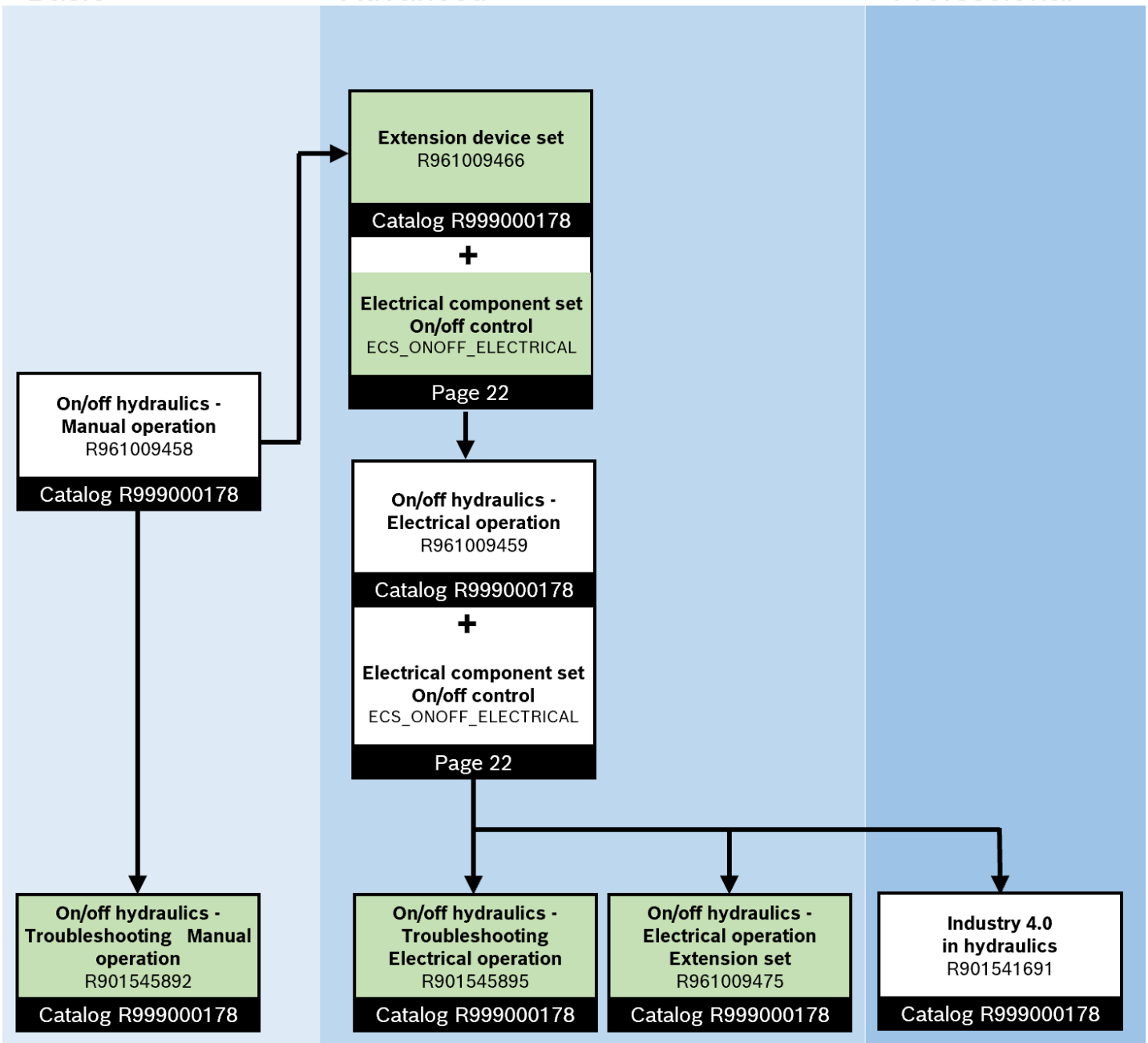

All listed topics available for either DS2 or DS4 training system

Common order examples:

On/Off hydraulics with manually operated valving- for teaching general hydraulic principles

Training Stand

Option 1 - Low cost but small user groups low upgradeability

1X) TS-DS2NA-1X/2H/M2 – Double sided trainer for 2 to 4 users, with fixed displacement gear pumps

1X) R987461960 – Component Storage Rack - Optional

Option 2 - Higher cost but larger user groups and infinite expandability

TS-DS4NA-1X/2H - for 3 to 6 users with variable displacement piston pumps

1X) R987358296 – Component Storage Rack – Optional

Recommended accessories for above training stands

2X) R961002927 – Pressure release coupling

2X) R961009563 – Base measuring set

Device set

2X) 961009458 – Device set for On/Off hydraulic with manual valves

1X) R901385282 – Trainers manual

The student manual R901385283 can be downloaded for free from DCA's "Learnworld"

Note: One (total) accumulator charging kit 0538103015 should be supplied for the lab

ON/OFF hydraulics with manual and electrically operated valving - For teaching general hydraulic and (ladder logic) electro-hydraulic principles

Training Stand

Option 1 - Low cost but small user groups low upgradeability

1X) TS-DS2NA-1X/2H/EP/M2 – Double sided trainer for 2 to 4 users, with fixed displacement gear pumps

1X) R987461960 – Component Storage Rack - Optional

Option 2 - Higher cost but larger user groups and infinite expandability

TS-DS4NA-1X/2H/EP - for 3 to 6 users with variable displacement piston pumps

1X) R987358296 – Component Storage Rack – Optional

Recommended accessories for above training stands

2X) R961002927 – Pressure release coupling

2X) R961009563 – Base measuring set

Device set

2X) R961009458 – Device set for On/Off hydraulic with manual valves

1X) R901385282 – Trainers manual

The student manual R901385283 can be downloaded for free from DCA's "Learnworld"

Note: One (total) accumulator charging kit 0538103015 should be supplied for the lab

2X) R961009466 – Upgrade hydraulic set from "On/Off-manual valves" to "On/Off-electrical valves"

2X) Electrical component set type ECS_ONOFF_ELECTRICAL consisting of the following:

1X) R987454216 - Housed operating module

6X) R901457044 - Solenoid cable with connector

2X) R961003488 – Pressure switch

2X) R900029597 - Measuring line set, small

4X) R961003106 – Proximity switch

1X) R901385284 – Trainers manual

The student manual R901385283 can be downloaded for free from DCA's "Learnworld"

Topic

ON/OFF hydraulics with manually operated valves – suitable for DS2NA or DS4NA training stand

This equipment package is focused on training in the following topics:

- Understanding the physical laws of hydraulics such as pressure, flow, pressure differential, cross sectional opening and flow
- Understanding and applying legal regulations and safety requirements
- Understand the function of basic hydraulic circuits
- Understand the typical behavior of hydraulic components in different operating situations
- Determine characteristic values and derive characteristic operating curves

For additional details please see catalog R999000178

Exercise books

The exercise books correspond to the lab equipment set and contain the following experiments. These books are available in a student and teacher (containing notes and answers) version

Teachers version:

R901385282 (EN)

R901424956 (FR)

R901385286 (ES)

Student version:

R901385283 (EN)

R901424966 (FR)

R901385287 (ES)



Topics

- | | |
|--|---|
| 01 Hydraulic system | 10 Throttle/check valve |
| 02 Hydraulic pump | 11 Flow control valve |
| 03 Differential cylinder (intensification) | 12 Pressure relief valve, direct and pilot operated |
| 04 Differential cylinder (flow) | 13 Control by means of pressure relief valves |
| 05 Hydraulic motor | 14 Pressure reducing valve |
| 06 4/3 directional control valve | 15 Hydraulic accumulator |
| 07 Check valve | 16 Differential circuit |
| 08 Pilot operated check valve | 17 Circulation circuit |
| 09 Throttle valve, adjustable | 18 Commissioning, troubleshooting |

See next page for associated hydraulic component set

Hydraulic component set ON/OFF control with lever operated valves - Complete
R961009458 - For additional details please see catalog R999000178



These devices are used to study basic hydraulics using practical exercises. Only industrial components are used. They have been adapted for use on the training equipment. The device set corresponds to the exercise book "On/off hydraulics – Manual operation (according to BIBB)" which deals with BIBB exercises A-H. The exercises with the components listed below can be carried out on workstations DS2NA and DS4NA. It is recommended that the DS2 training stand be equipped with measuring glass option M1 or M2.

Material no.	Description	Qty
R961009526	Single rod cylinder c/w protective cover for grid mounting 200 mm stroke	1
R961008748	Gerotor type hydraulic motor for grid mounting	1
R961002552	4/2 lever operated directional control valve for grid mountings spring return	2
R961002550	4/3 lever operated directional control valve for grid mounting Tandem centre (G spool)	1
R961002510	4/3 lever operated directional control valve for grid mounting Float centre (J spool)	1
R961002551	4/3 lever operated directional control valve for grid mounting Closed centre (E spool)	1
R961002520	Direct operated pressure relief valve for line mounting	2
R901460846	Pilot operated pressure relief valve for grid mounting	1
R961002544	Direct operated pressure reducing valve for grid mounting	1
R961002546	2-way flow control valve c/w bypass check valve for grid mounting	1
R961002539	Throttle valve for line mounting	1
R961002495	Throttle check valve for line mounting	1
R901462818	Check valve for line mounting	1
R961002513	Pilot operated check valve for grid mounting	1
R961002503	Diaphragm accumulator with safety isolation valving for grid mounting	1
R961002485	Hydraulic distributor for line or grid mounting	3
R961002491	Ball valve for line mounting	1
R961002715	Pressure gauge (100bar) with measuring hose	4
R961002474	Connection hose (630 mm)	8
R961004330	Connection hose (40 in/1000 mm)	4
R961002482	Connection hose with gauging point connection (1500 mm)	2

Topic

ON/OFF hydraulics with electrically operated valves – suitable for DS2NA or DS4NA training stand

Successful completion of the practical exercises provides hands on, knowledge of the use of electrically-operated on/off valves as well as the function and effect of the main components and basic circuits of on/off hydraulics.

This equipment package is focused on training in the following topics:

- Understanding the physical laws of hydraulics such as pressure, flow, pressure differential, cross sectional opening and flow
- Understanding and applying legal regulations and safety requirements
- Understand the function of basic hydraulic circuits
- Understand the typical behavior of hydraulic components in different operating situations
- Determine characteristic values and derive characteristic operating curves

For additional details please see catalog R999000178

Exercise books

The exercise books correspond to the lab equipment set and contain the following experiments. These books are available in a student and teacher (containing notes and answers) version

Teachers version:

R901385284 (EN)

R901425711 (FR)

R901385288 (ES)

Student version:

R901385285 (EN)

R901425712 (FR)

R901385289 (ES)



Topics:

- | | |
|---|---|
| 01 Hydraulic system | 13 Control by means of pressure relief valves |
| 02 Hydraulic pump | 14 Pressure reducing valve |
| 03 Differential cylinder (intensification) | 15 Hydraulic accumulator |
| 04 Differential cylinder (flow) | 16 Differential circuit |
| 05 Hydraulic motor | 17 Circulation circuit |
| 06 4/3 directional control valve | 18 Commissioning, troubleshooting |
| 07 Check valve | 19 Pressure switch (hysteresis) |
| 08 Pilot operated check valve | 20 Rapid motion/creep motion control |
| 09 Throttle valve, adjustable | 21 Load holding circuit with jerk-free lowering |
| 10 Throttle/check valve | 22 Rectifier circuit |
| 11 Flow control valve | 23 Circulation circuit for large flows |
| 12 Pressure relief valve, direct and pilot operated | 24 Accumulator charging circuit |

See the following pages for associated hydraulic component set and electrical component set

Hydraulic component set ON/OFF control with electrically operated valves - Complete
R961009459 For additional details please see catalog R999000178



These devices are used to study basic hydraulics using practical exercises. Only industrial components are used. They have been adapted for use on the training equipment. The device set corresponds to the exercise book "On/off hydraulics – Electrical operation (according to BIBB)" which deals with BIBB exercises A-H and Z1-Z3. The exercises with the components listed below can be carried out on workstations DS2NA and DS4NA. It is recommended that the DS2 training stand be equipped with measuring glass option M1 or M2.

*The training stand must be equipped with the central electrical panel "EP" in order to mount the electrical devices.

Material no.	Description	Qty
R961009526	Single rod cylinder c/w protective cover for grid mounting 200 mm stroke	1
R961008748	Gerotor type hydraulic motor for grid mounting	1
R961002547	4/2 lever operated directional control valve for grid mountings spring return	2
R961002548	4/3 lever operated directional control valve for grid mounting Tandem centre (G spool)	1
R961002554	4/3 lever operated directional control valve for grid mounting Float centre (J spool)	1
R961002549	4/3 lever operated directional control valve for grid mounting Closed centre (E spool)	1
R961002520	Direct operated pressure relief valve for line mounting	2
R901460846	Pilot operated pressure relief valve for grid mounting	1
R961002544	Direct operated pressure reducing valve for grid mounting	1
R961002546	2-way flow control valve c/w bypass check valve for grid mounting	1
R961002539	Throttle valve for line mounting	1
R961002495	Throttle check valve for line mounting	1
R901462818	Check valve for line mounting	1
R961002513	Pilot operated check valve for grid mounting	1
R961002503	Diaphragm accumulator with safety isolation valving for grid mounting	1
R961002485	Hydraulic distributor for line or grid mounting	3
R961002491	Ball valve for line mounting	1
R961002715	Pressure gauge (100 bar) with measuring hose	4
R961002474	Connection hose (630 mm)	8
R961004330	Connection hose (40 in/1000 mm)	4
R961002482	Connection hose with gauging point connection (1500 mm)	2

Electrical components for ON/OFF control with electrically operated valves – components must be ordered separately

ECS_ONOFF_ELECTRICAL



These devices are used to study basic hydraulics using practical exercises. Only industry standard components are used. They have been adapted for use on the training equipment. The devices correspond to the exercise book "On/off hydraulics – Electrical operation". The exercises with the components listed below can be carried out on DS2NA and DS4NA workstations.

The training stand must be equipped with the central electrical panel “EP” in order to mount the electrical devices.

It is recommended that the DS2 training stand be equipped with measuring glass option M1 or M2.

*The training stand must be equipped with the central electrical panel “EP” in order to mount the electrical devices.

Electrical Components for ON/OFF control with electrical valves

ECS_ONOFF_ELECTRICAL

Order the following items separately

Item	Material no.	Description	Qty
001	R987454216	Housed operating module for central panel mounting	1
		Consisting of:	
1.01	R961009676	Operating module	1
1.02		Enclosure for aluminum profile mounting	1
002	R961003488	Pressure switch electric with measuring hose and electrical cable	1
003	R961003106	Proximity switch Inductive	2
004	R901457044	Solenoid cable with LED black connector	3
005	R901508497	Connection cable set small	1





Upgrade from ON/OFF control with manual valves to electrically operated valves
R961009466 For additional details please see catalog R999000178

This set contains the hydraulic componentry required to upgrade from control with ON/OFF lever operated valves to ON/OFF with electrically operated valves. The training stand must be equipped with the central electrical panel "EP" in order to mount the electrical devices. It is recommended that the DS2 training stand be equipped with measuring glass option M1 or M2.

Item	Material no.	Description	Qty
003	R961002547	4/2 solenoid operated directional control valve for grid mounting spring return	2
004	R961002548	4/3 solenoid operated directional control valve for grid mounting Tandem centre (G spool)	1
005	R961002554	4/3 solenoid operated directional control valve for grid mounting Float centre (J spool)	1
006	R961002549	4/3 solenoid operated directional control valve for grid mounting Closed centre (E spool)	1

ON/OFF hydraulics – Accessories

For the exercises in ON/OFF hydraulics, you need measuring equipment for the flow, speed and pressure.
 For more accessories, please refer to page 52 and data sheet R999000178.
 We recommend the following:

Description	Mat. No.	Image
Basic measuring set One recommended per lab group <i>For additional details please see catalog R999000178</i>	R961009563	
Filling and testing device for hydraulic accumulator One recommended for each lab	0538103015	
Pressure release coupling One recommended per lab group <i>For additional details please see catalog R999000178</i>	R961002927	
Pressure gauge (100bar / 1500psi) with measuring hose Dual unit metric/imperial gauge assembly	R987414032	
Pilot operated pressure relief valve with external pilot and drain ports	R987414030	

**I/O connection module
R987454221**

The input/output connection module allows interconnection of the training hardware with simulation software (i.e. Automation Studio) in order to allow control of electrical valves and sensors.

The housed control unit mounts onto the central electrical panel and has the following connection possibilities.

- 8 digital inputs
- 8 analog inputs (0-10 VDC)
- 4 analog inputs 4-20 mA
- 6 valve connections
- 25-pole Sub-D connector for connection at valve terminal
- connections via 4mm safety sockets
- communication to PC via USB port

Suitable for DS2NA or DS4NA training stand

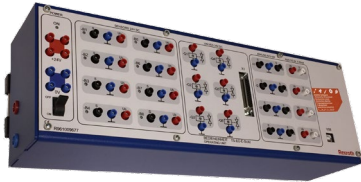

Item	Material no.	Description	Qty
001	R987454221	Housed I/O connection module for central panel mounting	1
		Consisting of:	
1.01	R961009677	I/O module to link hardware to simulation software	1
1.02		Enclosure for aluminum profile mounting	1
001.1		Software on CD-ROM (included in supply)	1
001.2		USB connection cable (included in supply)	1

Topic

ON/OFF hydraulics - Troubleshooting – suitable for DS2NA or DS4NA training stand

The contents of this learning topic provide support on how systematic troubleshooting in hydraulic systems can be achieved in a targeted manner. The troubleshooting refers to hydraulic circuits with manually or electrically operated directional control valves, pressure control valves and check valves.

The successful completion of the practical exercises provides hands on training in the different levels of troubleshooting with on/off hydraulics.

This equipment package is focused on training in the following topics:

- Understanding the physical laws of hydraulics such as pressure, flow, pressure differential, cross sectional opening and flow
- Understanding and applying legal regulations and safety requirements
- Understand the function of basic hydraulic circuits
- Understand the typical behavior of hydraulic components in different operating situations
- Determine characteristic values and derive characteristic operating curves

For additional details please see catalog R999000178

Exercise books

The exercise books correspond to the device sets. They build on the learning topics "On/off hydraulics – Manual operation and "On/off hydraulics – Electrical operation with further training in the topics commissioning and troubleshooting.

The exercises and tasks provide basic information and methods in a structured way with step-by-step instructions for the individual exercises.



Teaching and learning documents in one book

- Exercises with solutions: more far-reaching trainer information and contents such as measured values, calculation results, etc.
- Exercises: independent completion of calculations and measured value tables, etc.

Exercises with solutions (trainer/student manual):

R961003805 (EN)

R961003954 (ES)

Learning topics

With the help of logically structured, practical exercises, the trainee should:

- understand physical laws of hydraulics such as pressure difference, opening cross-section and flow,
- get to know and apply the legal regulations and safety requirements,
- understand the function of basic hydraulic circuits,
- get to know the systematic troubleshooting with different error types (adjustment errors, system errors).

Topics

No.	Exercise	Error type
01	Hydraulic clamping (check valve)	System error
02	Clamping equipment with hydraulic motor (pressure relief valve, directional control valve)	Adjustment error, system error
03	Clamping equipment with hydraulic motor (pressure relief valve, directional control valve)	Combination of adjustment and system error

See the following pages for associated hydraulic component sets

Hydraulic Component Set for teaching troubleshooting with manual valves

R961006619 For additional details please see catalog R999000178



The device set comprises components with installed defects to be used in exercise set-ups for the systematic troubleshooting in hydraulic systems.

The device set corresponds to the exercise book "Fault detection in hydraulic systems".

The exercises with the components listed below can be carried out on DS2NA and DS4NA training stands

Material no.	Description	Qty
R961006553	4/3 lever operated directional control valve for grid mounting tandem centre (G spool) - modified	1
R961006549	Direct operated pressure relief valve for line mounting - modified	1
R961006550	Pilot-operated pressure relief valve DB6K1-4X/50YV - modified	1
R961006552	Line mounted check valve S6A05-1X with hose 25 in. (630 mm) - modified	1
R961006596	Sight glass	1

* items 1 to 4 are not available individually

We recommend the accessories which are listed on page 37

Hydraulic Component Set for teaching troubleshooting with electrical valves

R961006620 For additional details please see catalog R999000178



The device set comprises components with installed defects to be used in exercise set-ups for the systematic troubleshooting in electro-hydraulic systems.

The device set corresponds to the exercise book "Fault detection in hydraulic systems".

The exercises with the components listed below can be carried out on DS2NA and DS4NA training stands

Material no.	Description	Qty
R961006551	4/3 solenoid operated directional control valve for grid mounting tandem centre (G spool) - modified	1
R961006549	Direct operated pressure relief valve for line mounting - modified	1
R961006550	Pilot-operated pressure relief valve DB6K1-4X/50YV - modified	1
R961006552	Line mounted check valve S6A05-1X with hose 25 in. (630 mm) - modified	1
R961006596	Sight glass	1

* items 1 to 4 are not available individually

We recommend the accessories which are listed on page 37

Learning topics – Continuous control valve technology

ON/OFF HYDRAULICS WITH DS4NA TRAINING SYSTEM

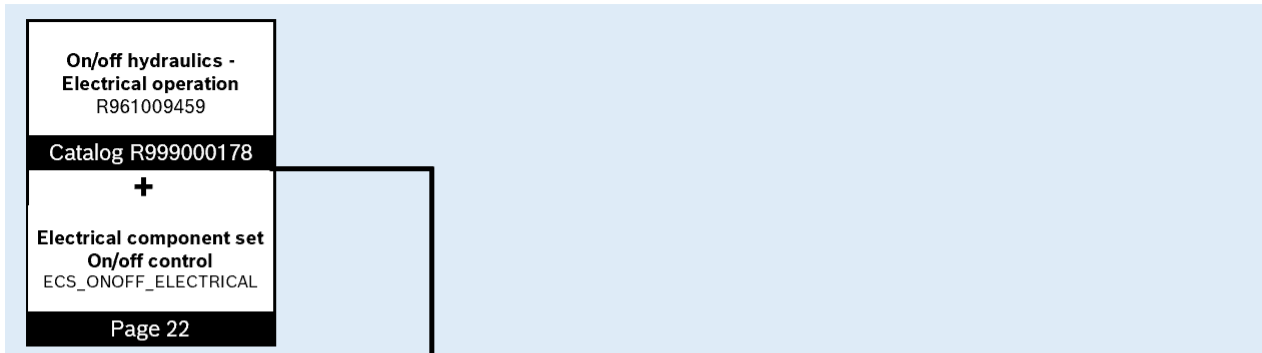

CONTINUOUS CONTROL VALVE TECHNOLOGY WITH DS4NA TRAINING SYSTEM

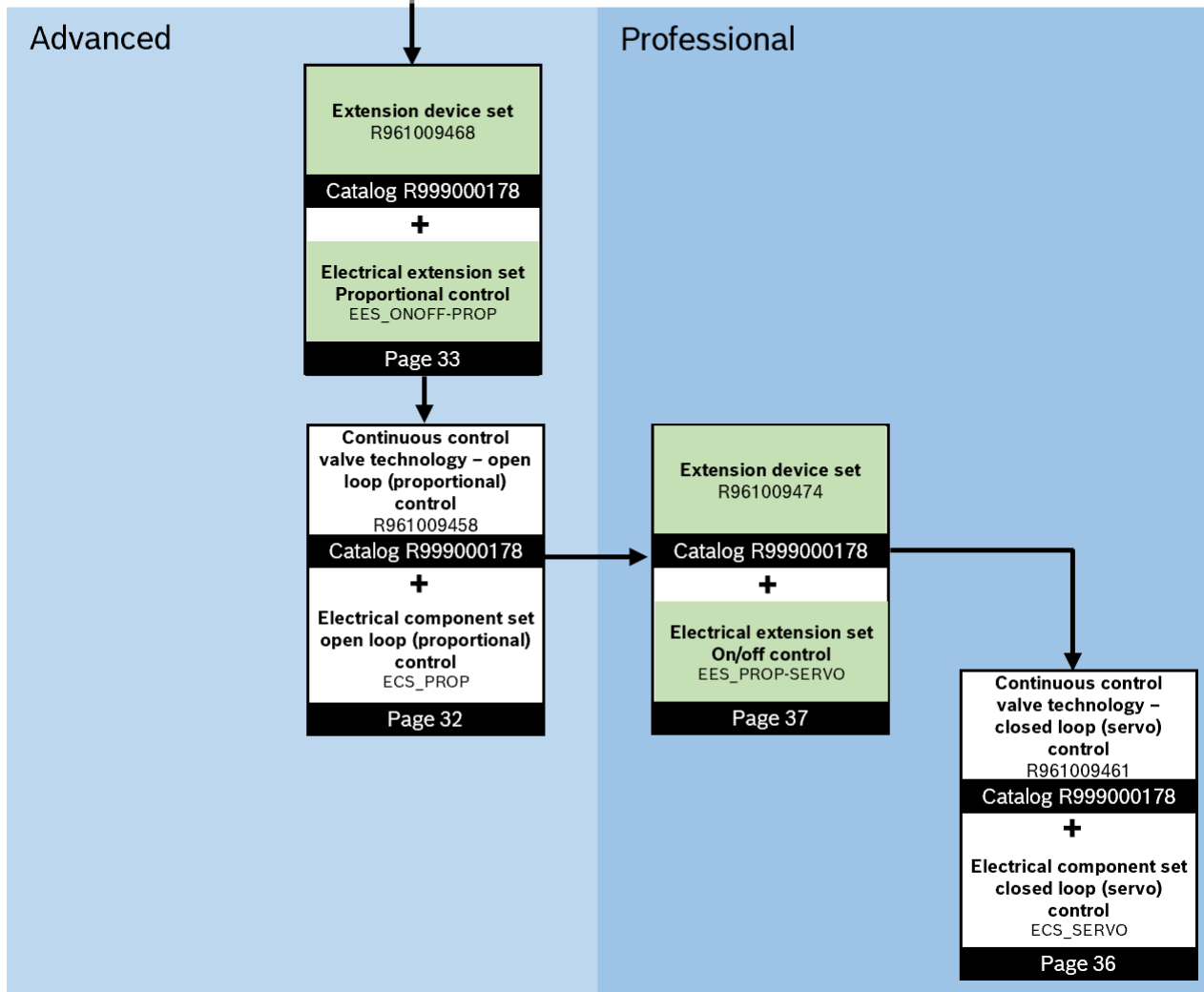

Continuous control valve topics only available for DS4 training system

Topic

Proportional (open loop) control – suitable for DS4NA training stand

Successful completion of the practical exercises provides hands on knowledge of the function and effect of the main components and basic circuits of continuous control valve technology.

This equipment package is focused on training in the following topics:

- Understanding the physical laws of hydraulics such as pressure, flow, pressure differential, cross sectional opening and flow
- Understanding and applying legal regulations and safety requirements
- Understand the function of basic hydraulic circuits
- Apply the most important symbols of proportional hydraulics, read circuit diagrams
- Get to know and understand the meaning and mode of operation of command value pre-setting, ramp function and signal sequences
- Practice the setting, commissioning and optimization of an electro-hydraulic system
- Determine characteristic values and derive characteristic curves from them.

For additional details please see catalog R999000178

Exercise books

The exercise books correspond to the lab equipment set and contain the following experiments. These books are available in a student and teacher (containing notes and answers) version

Teachers version:

R961003873 (EN)

R961003872 (ES)

Student version:

R961003875 (EN)

R961003874 (ES)



Topics

- 01 Moving cylinders with external potentiometer as command value preset
- 02 Moving cylinders with SWMA1 command value module as command value preset
- 03 Setting the SWMA1 command value module with 4 command values
- 04 Setting the SWMA1 command value module with 4 command values and ramps
- 05 Setting the braking distance according to the proximity switch signal
- 06 Pressure ratios at the continuous control valve and influence on velocity and braking distance
- 07 Setting a motion sequence with 4 quadrants
- 08 Setting a sequence with 2 proximity switches
- 09 Setting an automatic sequence with 3 proximity switches
- 10 Setting the system pressure by means of an external potentiometer
- 11 Moving a cylinder with two different pressures
- 12 Automatic sequence with continuous pressure control valve

See the following pages for associated hydraulic component set and electrical component set

Hydraulic Component Set for training in the topic of proportional (open loop) control - complete
R961009460 For additional details please see catalog R999000178



This device set is used to study electro-hydraulic control technology using practical exercises. Only industry standard components are used. These have been adapted for use on the training equipment. The device set corresponds to the exercise book "Proportional valve technology". The exercises with the components listed below can be carried out on training stand type DS4NA. The training stand must be equipped with the central electrical panel "EP" in order to mount the electrical devices.

Item	Material no.	Description	Qty
001	R961003495	Single rod cylinder c/w protective cover for grid mounting 400 mm stroke	1
002	R61002549	4/3 solenoid operated directional control valve for grid mounting Closed centre (E spool)	1
003	R961003533	4/3 proportional directional control valve c/w integrated electronics and spool position feedback. Assembly includes sandwich loading valve for grid mounting	1
004	R961002520	Direct operated pressure relief valve for line mounting	1
005	R961003924	Proportional pressure relief valve c/w integrated electronics for grid mounting	1
006	R961002495	Throttle check valve for line mounting	1
007	R901462818	Check valve for line mounting	1
008	R961002715	Pressure gauge (100bar) with measuring hose	3
009	R961002474	Connection hose (630 mm)	4
010	R961002476	Connection hose with gauging point connection (1000 mm)	3

**Electrical Component set for proportional (open loop) control – components must be ordered separately
ECS_PROP**

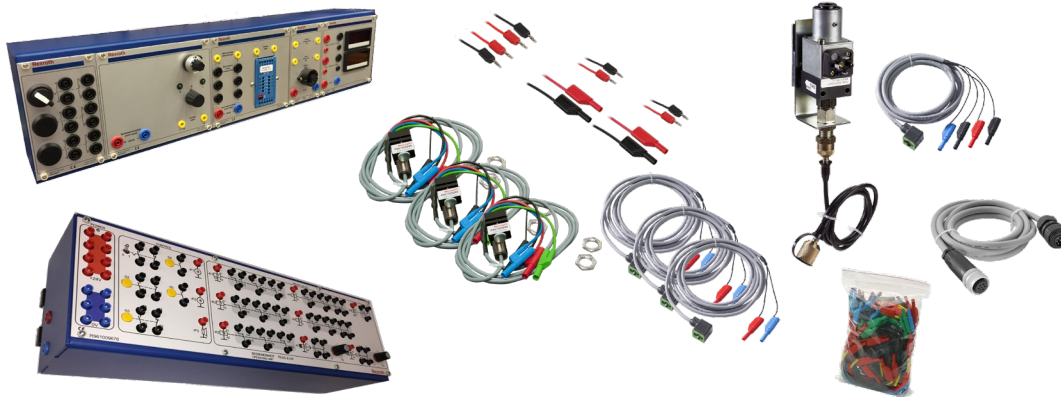

This component package includes all necessary electrical components for the proportional hydraulics exercises. The electrical switches, push buttons, relays and displays are incorporated in one operating unit housed for central panel mounting. All of the components for analog control such as display unit, set-point adjuster etc are housed together for grid mounting. This component package is required to carry out the exercises from the exercise book "Proportional valve technology" on a DS4NA training stand.

The training stand must be equipped with the central electrical panel "EP" in order to mount the electrical devices.

Order the following items separately

Item	Material no.	Description	Qty
001	R987454216	Housed operating module for central panel mounting Consisting of:	1
1.01	R961009676	Operating module	1
1.02		Enclosure for aluminum profile mounting	1
002	R961003488	Pressure switch electric with measuring hose	1
003	R961003106	Proximity switch Inductive	3
004	R901457044	Solenoid cable with LED black connector	3
005	R901508496	Connection cable set large	1
006	R987454217	Housed control electronics for grid mounting Consisting of:	1
6.01		Enclosure for grid mounting	1
6.02	R961009617	Push button/switch module	1
6.02	R961009623	Dual voltage display module	1
6.03	R961009630	Interconnection module	1
6.04	R961009631	Command value generator module - SWMA	1
6.05	R961009632	Command value generator +/- 10 VDC	1
007	R961003550	7-pin cable for integrated electronics	1
008	R901461031	Measuring cable set 2mm/2mm and 2mm/4mm	1

Upgrade from ON/OFF control with electrical valves to proportional (open loop) control

These expansion sets contain the hydraulic and electrical componentry required to upgrade from control with ON/OFF control with electrically operated valves to proportional (open loop) control.

The training stand must be equipped with the central electrical panel "EP" in order to mount the required electrical devices

Hydraulic equipment expansion set

R961009468 For additional details please see catalog R999000178

Item	Material no.	Description	Qty
001	R961003495	Single rod cylinder c/w protective cover for grid mounting 400 mm stroke	1
003	R961003533	4/3 proportional directional control valve c/w integrated electronics and spool position feedback. Assembly includes sandwich loading valve for grid mounting	1
005	R961003924	Proportional pressure relief valve c/w integrated electronics for grid mounting	1

Electrical equipment expansion set

EES_ONOFF-PROP

Order the following items separately

Item	Material no.	Description	Qty
003	R961003106	Proximity switch Inductive	1
005	R901508497	Connection cable set small	1
006	R987454217	Housed control electronics for grid mounting	1
		Consisting of:	
6.01		Enclosure for grid mounting	1
6.02	R961009617	Push button/switch module	1
6.02	R961009623	Dual voltage display module	1
6.03	R961009630	Interconnection module	1
6.04	R961009631	Command value generator module - SWMA	1
6.05	R961009632	Command value generator +/- 10 VDC	1
007	R961003550	7-pin cable for integrated electronics	1
008	R901461031	Measuring cable set 2mm/2mm and 2mm/4mm	1

Topic

Closed loop (servo) control – suitable for DS4NA training stand

The objectives of this learning topic are the familiarization and the use of a valve for closed-loop control with on-board electronics, a hydraulic cylinder with load unit and position transducer, and the corresponding set-point adjustments.

Successful completion of the practical exercises provides hands on knowledge of the practical application of a simple electro-hydraulic position control circuit.

This equipment package is focused on training in the following topics:

- Understanding the physical laws of hydraulics such as pressure, flow, pressure differential, cross sectional opening and flow
- Understanding and applying legal regulations and safety requirements
- Understand the function of basic hydraulic circuits
- Apply the most important symbols of closed-loop control hydraulics, read circuit diagrams,
- Understand the meaning and mode of operation of command value pre-setting, ramp function and signal sequences
- Practice the setting, commissioning and optimization of an electro-hydraulic system
- Determine characteristic values and derive characteristic curves from them
- Identify disadvantages of an open loop control
- Understand function and importance of the setting of a controller
- Identify the advantages of a control
- Practice the commissioning and optimization of an electro-hydraulic position control circuit with variable loads.

For additional details please see catalog R999000178

Exercise books

The exercise books correspond to the lab equipment set and contain the following experiments. These books are available in a student and teacher (containing notes and answers) version

Teachers version:
R901503282 (EN)

Student version:
R901503283 (EN)



Topics

- 01 Setting a position with a 4/3 directional control valve
- 02 Setting a position with a continuous control valve
- 03 Position control

See the following pages for associated hydraulic component set and electrical component set

Hydraulic component set for training in the topic of servo (closed loop) control - complete
R961009461 For additional details please see catalog R999000178

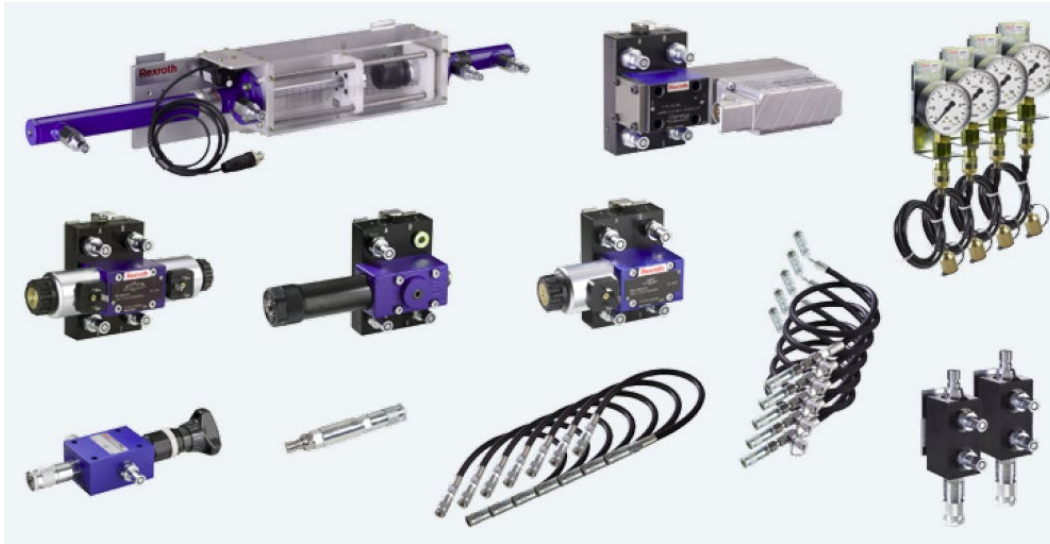

This device set is used to study practical applications of a simple electro-hydraulic position control loop. Only industry standard components are used which have been adapted for use on the training equipment. The device set corresponds to the exercise book "Analog position control loop". The exercises with the components listed below can be carried out on the DS4NA workstation

Item	Material no.	Description	Qty
001	R961004486	Load unit, controllable, for dynamic simulation for grid mounting	1
002	R961002509	4/4-way directional high-response valve 4WRPEH6 with integrated electronics for grid mounting	1
003	R961002547	4/2 solenoid operated directional control valve for grid mounting	1
004	R961002549	4/3 solenoid operated directional control valve for grid mounting Closed centre (E spool)	1
005	R961002520	Direct operated pressure relief valve for line mounting	1
006	R961002544	Direct operated pressure reducing valve for grid mounting	1
007	R901462818	Check valve for line mounting	1
008	R961002485	Hydraulic distributor for line or grid mounting	2
009	R961002715	Pressure gauge (100bar) with measuring hose	4
010	R961002474	Connection hose (630 mm)	7
011	R961004330	Connection hose with 90 deg. Fitting and gauging point connection (1000 mm)	5

**Electrical Component set for servo (closed loop) control – components must be ordered separately
ECS_SERVO**



This component package includes all necessary electrical components for the closed-loop control hydraulics exercises. The electrical switches, push buttons, relays and displays are incorporated in one operating unit housed for central panel mounting. All of the components for analog control such as display unit, set-point adjuster etc. and closed loop controller are housed as assemblies for grid mounting. This component package is required to carry out the exercises from the exercise book " Analog position control loop " on a DS4NA training stand. The training stand must be equipped with the central electrical panel "EP" in order to mount the electrical devices.

Order the following items separately

Item	Material no.	Description	Qty
001	R987454216	Housed operating module for central panel mounting Consisting of:	1
1.01	R961009676	Operating module	1
1.02		Enclosure for aluminum profile mounting	1
002	R987454217	Housed control electronics for grid mounting Consisting of:	1
2.01		Enclosure for grid mounting	1
2.02	R961009617	Push button/switch module	1
2.02	R961009623	Dual voltage display module	1
2.03	R961009630	Interconnection module	1
2.04	R961009631	Command value generator module - SWMA	1
2.05	R961009632	Command value generator +/- 10 VDC	1
003	R987454219	Housed PID controller for grid mounting Consisting of:	1
3.1		Enclosure for grid mounting	1
3.2	R961004782	Analog controller module	1
004	R961003106	Proximity switch Inductive	1
005	R961003550	7-pin cable for integrated electronics	1
006	R901461031	Measuring cable set 2mm/2mm and 2mm/4mm	1
008	R901508496	Connection cable set large	1
009	R901457044	Solenoid cable with LED black connector	3

Upgrade from proportional (open loop) control to servo (closed loop) control

These sets contain the hydraulic and electrical componentry required to upgrade from proportional (open loop) control to servo (closed loop) control.

The training stand must be equipped with the central electrical panel "EP" in order to mount the required electrical devices

Hydraulic equipment expansion set

R961009474 For additional details please see catalog R999000178

Item	Material no.	Description	Qty
001	R961004486	Load unit, controllable, for dynamic simulation for grid mounting	1
002	R961002509	4/4-way directional high-response valve 4WRPEH6 with integrated electronics for grid mounting	1

Electrical equipment expansion set EES_PROP-SERVO

Order the following items separately





Item	Material no.	Description	Qty
003	R987454219	Housed PID controller for grid mounting	1
		Consisting of:	
3.01		Enclosure for grid mounting	1
3.02	R961004782	Analog controller module	1

Continuous control valve technology – Accessories

For the exercises in continuous control valves, you need measuring equipment for the flow and pressure measurement as well as a multi-meter.

For more accessories, please refer to the accessories section of this document.

We recommend the following:

Item	Description	Mat. No.	Image
1	Basic measuring set <i>For additional details please see catalog R999000178</i>	R961009563	
2	Gear type flow rate sensor and Measuring cable for ISDS and Measuring instrument set 3020 <i>For additional details please see catalog R999000178</i>	R961002508 R900733207 R913038909	
3	Multi-meter VC175 <i>For additional details please see catalog R999000178</i>	R913038027	
4	Pressure release coupling <i>For additional details please see catalog R999000178</i>	R961002927	

Learning topics – Mobile hydraulics

ON/OFF HYDRAULICS WITH DS4NA TRAINING SYSTEM

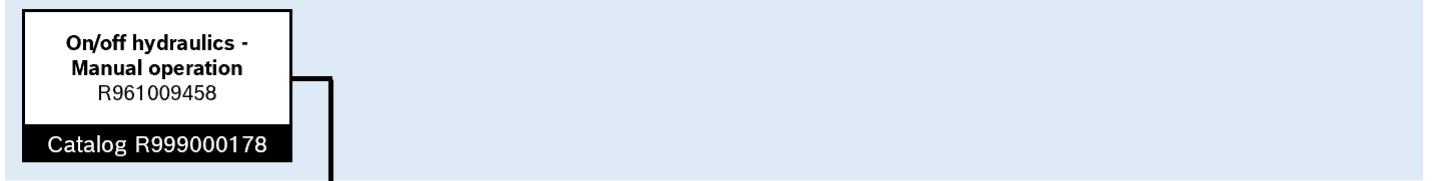

MOBILE HYDRAULICS TECHNOLOGY WITH DS4NA TRAINING SYSTEM

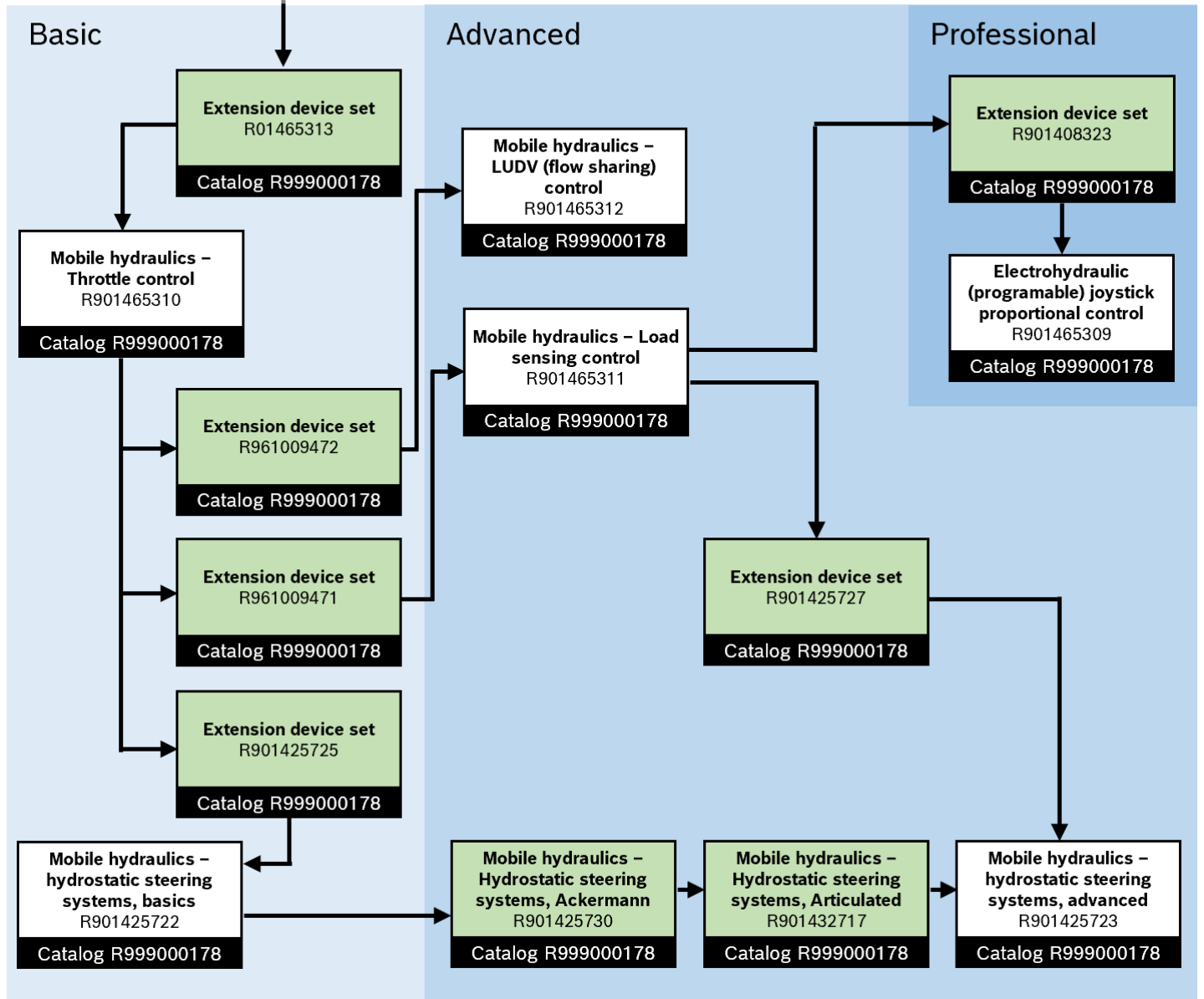

Mobile hydraulics topics only available for DS4 training system

Topic

Mobile hydraulics – Throttle (Open Centre) Control – suitable for DS4NA training stand

The objectives of this learning topic are the familiarization with the use of a mobile control block with throttle control.

Successful completion of the practical exercises provides hands on knowledge of function and effect of the main components and basic circuits of mobile hydraulics.

Exercise books

The exercise books correspond to the lab equipment set and contain the following experiments.

These device sets and the corresponding exercises build on the knowledge gained via general hydraulic technology training with either “ON/OFF hydraulics – Manual operation” or “Mobile hydraulic fundamentals”

For additional details please see catalog R999000178

Teachers version:

Exercises with solutions: more far-reaching trainer information and contents such as measured values, calculation results, etc.

R961005094 (EN)

Student version:

Exercises: independent completion of calculations and measured value tables, etc.

R961005093 (EN)



Learning contents

With the help of logically structured, practical exercises, the trainee should:

- understand physical laws of hydraulics such as pressure difference, opening cross-section and flow,
- read specific switching symbols
- identify the function of the throttle control
- get to know components such as 6/3 directional control valve, load holding valve, primary and outlet pressure valve, hydraulic pilot control
- understand the connection between control and velocity
- get to know the function of the throttle control in parallel operation
- work out the function and application of the hydraulic control
- determine characteristic values and derive characteristic curves from them

Topics

- | | |
|---------------------------------------|----------------------------------|
| 01 Flow distribution | 06 Secondary valve |
| 02 Pressure control and force control | 07 Parallel operation |
| 03 Hydraulic pilot control | 08 Control characteristic |
| 04 Speed with different loads | 09 Lower boom and force build-up |
| 05 Load holding valve | |
| 06 4/3 directional control valve | |

See next page for associated hydraulic component set

Hydraulic component set Mobile Hydraulic - Throttle (Open centre) Control - Complete R901465310 For additional details please see catalog R999000178

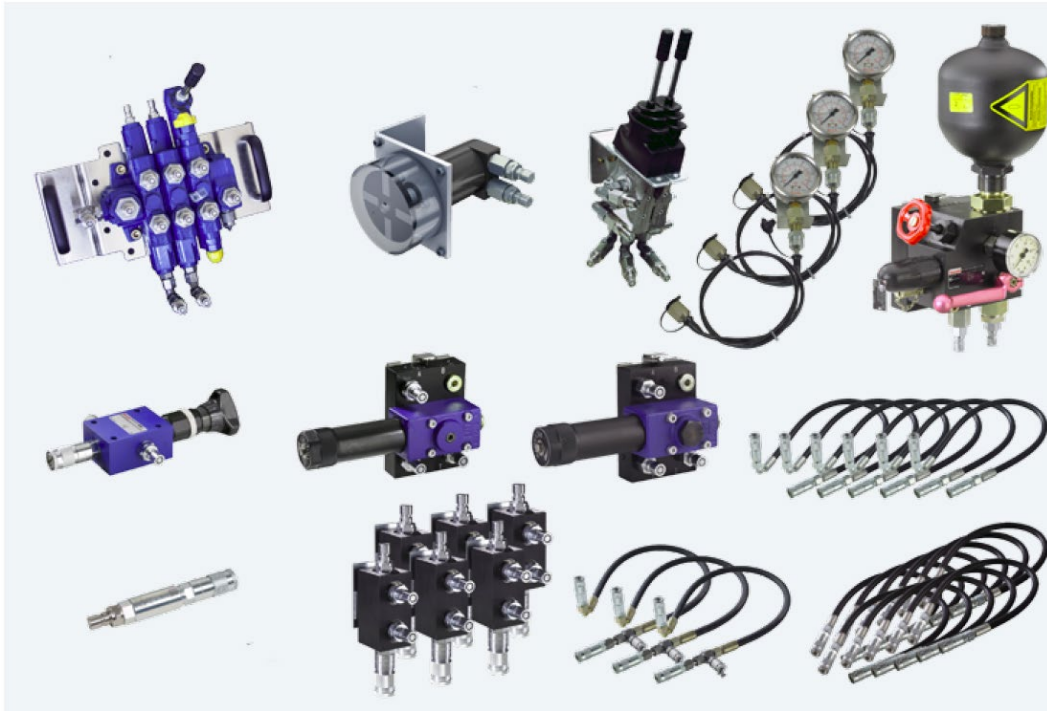

(separate order)

This device set is used to study practical applications from the mobile control technology. Only industry standard components are used. These have been adapted for use on the training equipment.

The device set corresponds to the exercise book "Mobile hydraulics – Throttle control 3SM-12".

The exercises with the components listed below can be carried out on the DS4NA training stand

Item	Material no.	Description	Qty
001	R961005970	Mobile control block Throttle control 3 SM12	1
002	R961005967	Hydraulic pilot control unit 2 levers 2-2TH6	1
003	R961008748	Planetary motor	1
004	R961002520	Direct operated pressure relief valve for line mounting	1
005	R961002544	Direct operated pressure reducing valve for grid mounting	1
006	R961002558	Direct operated pressure sequence valve	1
007	R901462818	Check valve for line mounting	1
008	R961002503	Diaphragm accumulator with safety isolation valving for grid mounting	1
009	R961002485	Hydraulic distributor for line or grid mounting	6
010	R961002715	Pressure gauge (100bar) with measuring hose	3
011	R961002474	Connection hose (630 mm)	11
012	R961004329	Connection hose (700 mm) with 90° fitting and gauging point connection	3
013	R961004331	Connection hose (1000 mm) with 90° fitting	6
Necessary accessory			
020	R961004005	80 kg. stationary loading unit	1

Upgrade from ON/OFF with manual valves to Mobile Hydraulic - Throttle Control
R01465313 For additional details please see catalog R999000178

This component package contains the components required to upgrade from the ON/OFF with manual valves to mobile hydraulic throttle control.

Item	Material no.	Description	Qty
001	R961005970	Mobile control block Throttle control 3 SM12	1
002	R961005967	Hydraulic pilot control unit 2 levers 2-2TH6	1
006	R961002558	Direct operated pressure sequence valve	1
009	R961002485	Hydraulic distributor for line or grid mounting	3
011	R961002474	Connection hose (630 mm)	3
012	R961004329	Connection hose (700 mm) with 90° fitting and gauging point connection	3
013	R961004331	Connection hose (1000 mm) with 90° fitting	2
Necessary accessory			
020	R961004005	80 kg. stationary loading unit	1

Topic

Mobile Hydraulic – Load Sensing (LS) Control – suitable for DS4NA training stand

The objectives of this learning topic are the familiarization with the use of a mobile control block with load-sensing control.

Successful completion of the practical exercises provides hands on knowledge of the function and effect of the main components and basic circuits of mobile hydraulics.

Exercise books

The exercise books correspond to the lab equipment set and contain the following experiments.

These device sets and the corresponding exercises build on the knowledge gained via general hydraulic technology training with either “ON/OFF hydraulics – Manual operation” or “Mobile hydraulic fundamentals” and “Mobile Hydraulics – Throttle Control”

For additional details please see catalog R999000178

Teachers version:

Exercises with solutions: more far-reaching trainer information and contents such as measured values, calculation results, etc.

R961005147 (EN)

R901206091 (ES)

Student version:

Exercises: independent completion of calculations and measured value tables, etc.

R961005146 (EN)

R901206157 (ES)



Learning contents

With the help of logically structured, practical exercises, the trainee should:

- understand physical laws of hydraulics such as pressure difference, opening cross-section and flow
- read specific switching symbols
- identify the function of the load sensing control
- get to know components such as 4/3 directional control valve, load holding valve, primary and secondary valve, pressure compensator, hydraulic pilot control
- understand the connection between control and velocity
- get to know the function of the load sensing control in parallel operation
- work out the function and application of the hydraulic pilot control
- determine characteristic values and derive characteristic curves from them

Topics

01 Flow distribution

02 Pressure control and force control

03 Hydraulic pilot control

04 Speed with different loads

05 Load holding valve

06 4/3 directional control valve

06 Secondary valve

07 Parallel operation

08 Control characteristic

09 Lower boom and force build-up

See next page for associated hydraulic component set

Hydraulic component set Mobile Hydraulic – Load sensing (LS) Control - Complete
R901465311 For additional details please see catalog R999000178



(separate order)

This device set is used to study practical applications from the mobile control technology. Only industry standard components are used. These have been adapted for use on the training equipment.

The device set corresponds to the exercise book "Mobile hydraulics – Load Sensing Control 2M4-12".

The exercises with the components listed below can be carried out on the DS4NA training stand.

Item	Material no.	Description	Qty
001	R961005969	Mobile control block Load sensing control 2M4-12	1
002	R961005967	Hydraulic pilot control unit 2 levers 2-2TH6	1
003	R961008748	Planetary motor	1
004	R961002520	Direct operated pressure relief valve for line mounting	1
005	R961002544	Direct operated pressure reducing valve for grid mounting	1
006	R961002558	Direct operated pressure sequence valve	1
007	R961002539	Throttle valve for line mounting	1
008	R901462818	Check valve for line mounting	1
009	R961002503	Diaphragm accumulator with safety isolation valving for grid mounting	1
010	R961002485	Hydraulic distributor for line or grid mounting	5
011	R961002715	Pressure gauge (100bar) with measuring hose	3
012	R961002474	Connection hose (630 mm)	10
013	R961004329	Connection hose (700 mm) with 90° fitting and gauging point connection	3
014	R961004331	Connection hose (1000 mm) with 90° fitting	8
Necessary accessory			
020	R961004005	80 kg. stationary loading unit	1

Upgrade from “Mobile Throttle (open centre) control” to “Mobile Load Sensing (LS) control”
R961009471 *For additional details please see catalog R999000178*

This set contains the components required to upgrade from the mobile hydraulic fundamentals to mobile hydraulic throttle control.

Item	Material no.	Description	Qty
001	R961005969	Mobile control block load-sensing control 2M4-12	1
007	R961002539	Throttle valve for line mounting	1
014	R961004331	Connection hose (1000 mm) with 90° fitting	2

Topic

Mobile hydraulic – Flow Sharing (LUDV) Control – suitable for DS4NA training stand

The objectives of this learning topic are the familiarization with the use of a mobile control block with LUDV control (load pressure-independent flow distribution also known as flow sharing).

Successful completion of the practical exercises provides hands on knowledge of the function and effect of the main components and basic circuits of mobile hydraulics.

Exercise books

The exercise books correspond to the lab equipment set and contain the following experiments.

These device sets and the corresponding exercises build on the knowledge gained via general hydraulic technology training with either “ON/OFF hydraulics – Manual operation” or “Mobile hydraulic fundamentals” and “Mobile hydraulics – Throttle and Load-sensing control”.

The exercises and tasks provide basic information and methods in a structured way with step-by-step instructions for the individual exercises.

For additional details please see catalog R999000178

Teachers version:

Exercises with solutions: more far-reaching trainer information and contents such as measured values, calculation results, etc.

R961005149 (EN)

Student version:

Exercises: independent completion of calculations and measured value tables, etc.

R961005148 (EN)



Learning contents

With the help of logically structured, practical exercises, the trainee should:

- understand physical laws of hydraulics such as pressure difference, opening cross-section and flow
- read specific switching symbols
- identify the function of the flow sharing (LUDV) control
- get to know components such as 4/3 directional control valve, load holding valve, primary and outlet pressure valve, hydraulic pilot control
- understand the connection between control and velocity
- get to know the function of the flow sharing (LUDV) control in parallel operation
- work out the function and application of the hydraulic control
- determine characteristic values and derive characteristic curves from them

Topics

01 Pressure setting and hydraulic pilot control
02 Setting actuator speeds by means of stroke limitation
03 Influence of pipelines

04 Influence of loads
05 Stroke limitation with changing force direction
06 Effect of external force on boom cylinder
07 LUDV (flow sharing) system

See next page for associated hydraulic component set

Hydraulic component set Mobile Hydraulic – LUDV (flow sharing) Control - Complete R901465312 For additional details please see catalog R999000178

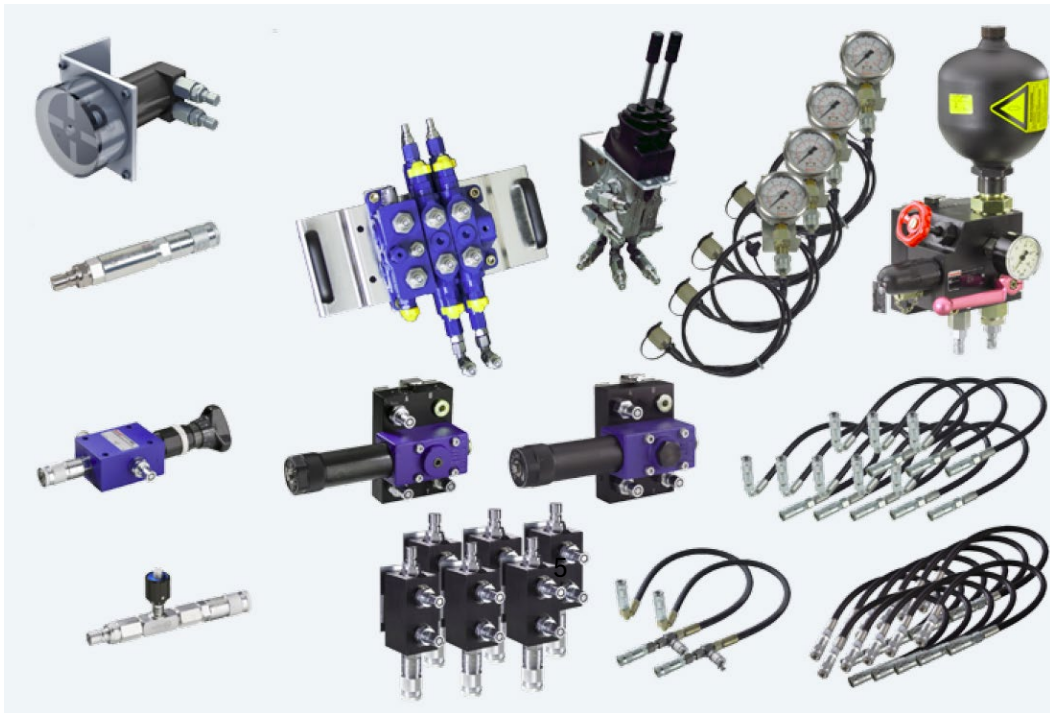

14



(separate order)

This device set is used to study practical applications from the mobile control technology. Only industry standard components are used. These have been adapted for use on the training equipment. The device set corresponds to the exercise book "Mobile hydraulics – LUDV Control 2SX-12". The exercises with the components listed below can be carried out on the DS4NA training stand.

Item	Material no.	Description	Qty
001	R961005966	Mobile control block flow sharing (LUDV) control 2SX-12	1
002	R961005967	Hydraulic pilot control unit 2 levers 2-2TH6	1
003	R961008748	Planetary motor	1
004	R961002520	Direct operated pressure relief valve for line mounting	1
005	R961002544	Direct operated pressure reducing valve for grid mounting	1
006	R961002558	Direct operated pressure sequence valve	1
007	R961002539	Throttle valve for line mounting	1
008	R901462818	Check valve for line mounting	1
009	R961002503	Diaphragm accumulator with safety isolation valving for grid mounting	1
010	R961002485	Hydraulic distributor for line or grid mounting	6
011	R961002715	Pressure gauge (100bar) with measuring hose	4
012	R961002474	Connection hose (630 mm)	11
013	R961004329	Connection hose (700 mm) with 90° fitting and gauging point connection	2
014	R961004331	Connection hose (1000 mm) with 90° fitting	8
Necessary accessory			
020	R961004005	80 kg. stationary loading unit	1

Upgrade from “Mobile Throttle (open centre) control” to “Mobile LUDV (flow sharing) control”

R961009472 *For additional details please see catalog R999000178*

This set contains the components required to upgrade from the mobile throttle control to mobile flow sharing (LUDV) control

Item	Material no.	Description	Qty
001	R961005969	Mobile control block flow sharing (LUDV) control 2SX12	1
007	R961002539	Throttle valve for line mounting	1
011	R961002715	Pressure gauge (100bar) with measuring hose	1
014	R961004331	Connection hose (1000 mm) with 90° fitting	2

Mobile hydraulics – Accessories

For the exercises in mobile hydraulics, you need measuring equipment for flow, speed and pressure measurement. For more accessories, please refer to the accessories section of this document. We recommend the following:

Item	Description	Mat. No.	Image
1	Basic measuring set <i>For additional details please see catalog R999000178</i>	R961009563	
2	Gear type flow rate sensor <i>For additional details please see catalog R999000178</i> and Measuring cable for ISDS <i>For additional details please see catalog R999000178</i> and Measuring instrument set 3020 <i>For additional details please see catalog R999000178</i>	R961002508 R900733207 R913038909	
3	Multi-meter VC175 <i>For additional details please see catalog R999000178</i>	R913038027	
4	Filling and testing device for hydraulic accumulator	0538103015	
5	Pressure release coupling <i>For additional details please see catalog R999000178</i>	R961002927	

Additional Componentry

Hydraulic components



All of the componentry shown in the component and upgrade sets are available as separate order. Additional componentry is available which is not contained in any of the previously listed component or upgrade sets. Please reference Bosch Rexroth data sheet R999000178 for a complete list of all available components.

Measuring equipment

The measuring devices shown in the recommended accessory pages are available as separate order. Additional measuring devices and systems are also available.

Please reference Bosch Rexroth data sheet R999000178 for a complete list of all available measuring devices.

The following measuring devices are dual scale (metric/Imperial) for use in North America

Mat. No.	Description	Image
R987414032	Pressure gauge 1500psi (100bar) with measuring hose	
R987425687	Flow meter .25 to 2.0 GPM (1.0 to 7.5 l/min) for line mounting	









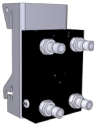

Electrical components

All of the componentry shown in the component and upgrade sets are available as separate order. Additional electrical devices are available which is not contained in any of the previously listed component or upgrade sets. Please reference Bosch Rexroth data sheet R999000178 for a complete list of all available components

Spare parts

The following spare parts are typical to the DS2NA and DS4NA training systems.

Please reference Bosch Rexroth data sheet R999000178 for a comprehensive list of all available spare parts

Mat. No.	Description	Image
R928005837	Return line filter element 10 micron return line filter for installation on TS-DS4NA training systems	
R*****	Return line filter element - SFC-3510-E 10 micron return line spin-on element for installation on TS-DS2NA training system.	
R961002568	Component plate with connection hole pattern according to ISO 4401-03-02-0-05, with clamping mechanism for grid and connections via self-sealing coupling plugs <i>For additional details please see catalog R999000178</i>	
R987410286	Universal mounting bracket Universal bracket for mounting components to the grid	
R961000482	Male quick disconnect – G1/4 ¼ BSPP male thread connection <i>For additional details please see catalog R999000178</i>	
R961000480	Female quick disconnect – G1/4 ¼ BSPP male thread connection for line mount devices <i>For additional details please see catalog R999000178</i>	
R961000481	Female quick disconnect – M16 x 1.5 M16 x 1.5 male thread connection for hose ends <i>For additional details please see catalog R999000178</i>	
R961009528	Replacement protective cover for 200 mm stroke cylinder (cylinder Material no. R961009526) <i>For additional details please see catalog R999000178</i>	
R961000369	Replacement protective cover for 400 mm stroke cylinder (cylinder Material no. R961003495) <i>For additional details please see catalog R999000178</i>	
R961008749	Replacement protective cover for planetary motor (motor Material no. R961008749) <i>For additional details please see catalog R999000178</i>	

For additional information and details regarding all hydraulic components and accessories for training please reference our full *Hydraulic Training System* datasheet R999000178

For additional information and details regarding all pneumatic components and accessories please reference our full *Pneumatic Training System* datasheet R999000218

For additional information regarding teacher and student manuals, as well as instructor training tools and resources please reference our full *Learning Media* datasheet DCA-DE_EN_ES_000009

Also available (contact us for more information)

Sensor technology

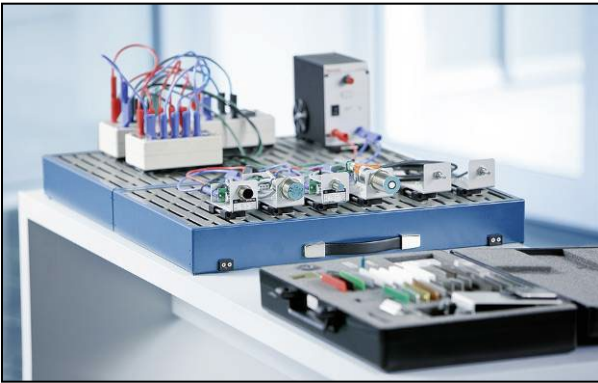

Training seminars



PLC technology

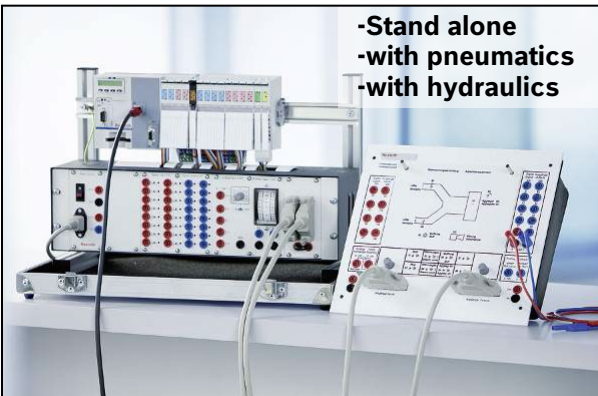

On-line training courses



Mechatronic modules and systems



Training aides



Bosch Rexroth Canada Corp.
490 Prince Charles Drive S.
Welland, ON, Canada
L3B 5R6
Tel (905) 735-0510
training@boschrexroth.ca
www.boschrexroth.ca/training

Bosch Rexroth Corporation
2315 City Line Rd.
Bethlehem, PA, USA
18017
Tel (610) 694-8300
training@boschrexroth.com
www.boschrexroth-us.com

© All rights reserved by Bosch Rexroth AG, also in the event of trademark registrations.

All rights of disposal such as for copying or distribution remain with Bosch Rexroth AG.

The data specified is solely provided to describe the product. This document cannot be used to derive certain characteristics or suitability of use for a particular purpose. The statements of this document do not relieve the user of his duty to make his own evaluations and inspections. It must be noted that our products are subject to natural wear and aging processes.

Reproduction expressly prohibited – Modifications reserved